

THIS PRINT IS THE PROPERTY OF
 HVRT CORP. ALL INFORMATION
 HERE ON IS CONFIDENTIAL. IT IS LOANED SUBJECT
 TO RETURN UPON DEMAND AND IN CONDITION THAT
 IT NOT BE REPLICATED OR USED IN ANY WAY
 DETRIMENTAL TO HVRT CORP.

REVISION HISTORY					
REV	DESCRIPTION	DWG. BY	DATE	ECO	APPROVED
A	SET TO CURRENT REVISION LEVEL	SLH	11/1/2017	H1	CR
B	UPDATE/ADD DIMENSIONS	SLH	6/7/2018	H10	CR
C	ADD "TREMOR4"	SLH	4/16/2020	H13	CR
D	ADD LINE THICKNESSES	SLH	4/27/2020	H14	CR

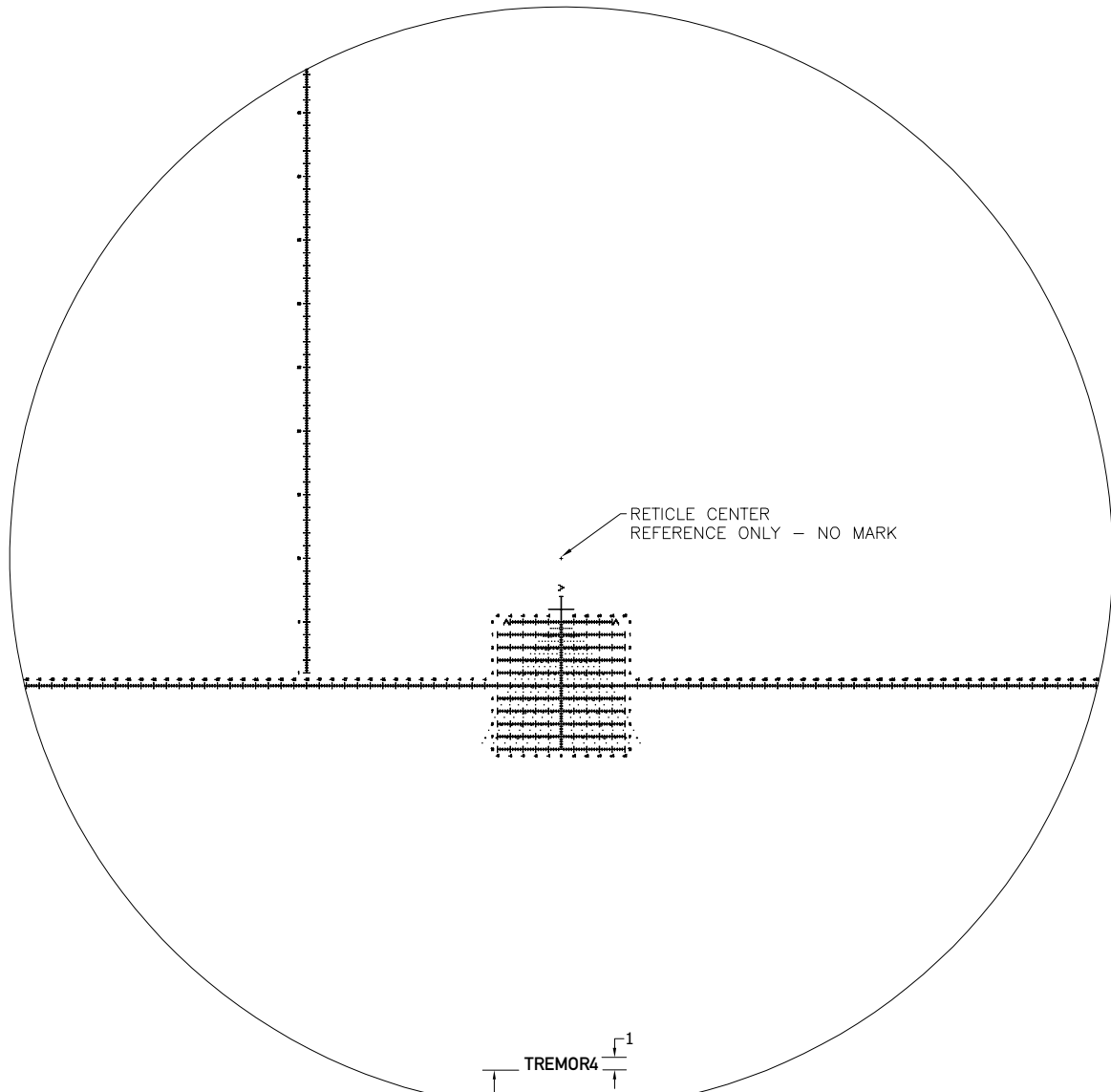

FONT IS DIM 1451 Mittlestrich
 ALL DIMENSIONS ARE IN MRAD (MIL)



APPD BY: N. GALLERY	DATE: 6/07/2018
APPD BY: C. RUNIA	DATE: 6/07/2018
HVRT CORP. 336 HAZEN LANE OROFINO, ID 83544	

PART DESCRIPTION Tremor4 - GENERIC		PART # Tremor4 - GENERIC	
DWG. BY: SLH		DATE: 6/06/2018	SHEET 1 OF 5

THIS PRINT IS THE PROPERTY OF
 HVRT CORP. ALL INFORMATION
 HERE ON IS CONFIDENTIAL. IT IS LOANED SUBJECT
 TO RETURN UPON DEMAND AND IN CONDITION THAT
 IT NOT BE REPLICATED OR USED IN ANY WAY
 DETRIMENTAL TO HVRT CORP.

REVISION HISTORY					
REV	DESCRIPTION	DWG. BY	DATE	ECO	APPROVED
A	SET TO CURRENT REVISION LEVEL	SLH	11/1/2017	H1	CR
B	UPDATE/ADD DIMENSIONS	SLH	6/7/2018	H10	CR
C	ADD "TREMOR4"	SLH	4/16/2020	H13	CR
D	ADD LINE THICKNESSES	SLH	4/27/2020	H14	CR

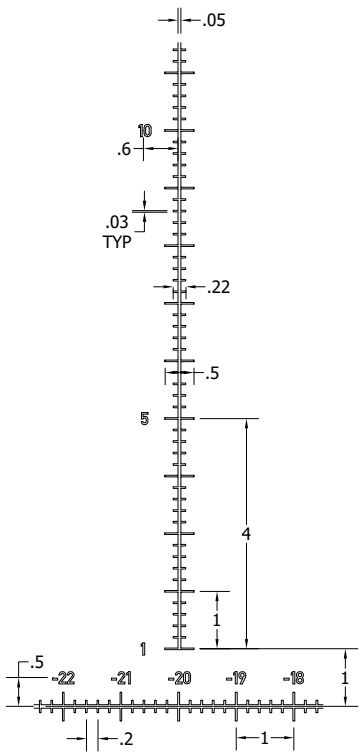
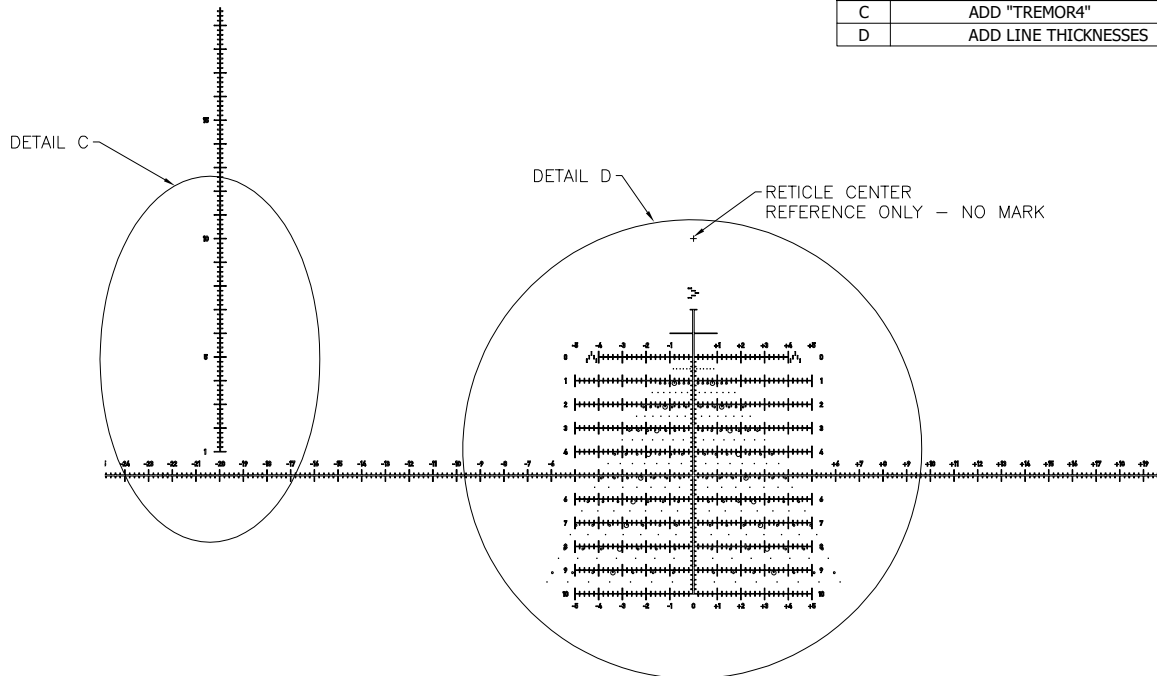

DETAIL C

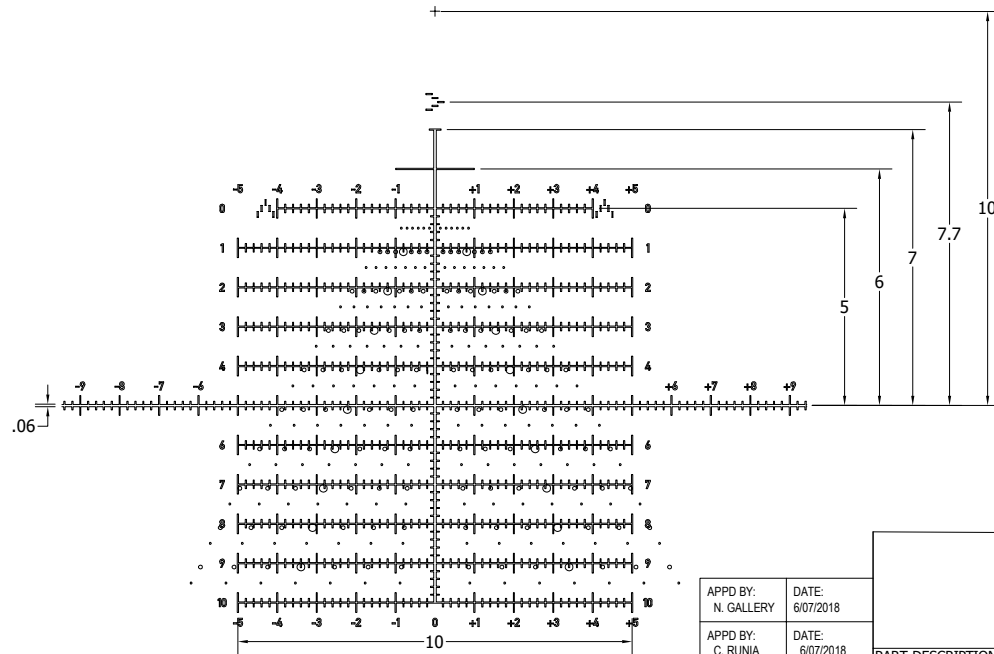

DETAIL D

FONT IS DIM 1451 Mittelschrift
 ALL DIMENSIONS ARE IN MRAD (MIL)

APPD BY:
N. GALLERY

DATE:
6/07/2018

APPD BY:
C. RUNIA

DATE:
6/07/2018

HVRT CORP.
 336 HAZEN LANE
 OROFINO, ID 83544

		PART #	
		Tremor4 - GENERIC	
PART DESCRIPTION		REV	
Tremor4 - GENERIC		D	
DWG. BY: SLH		SHEET 2 OF 5	

DATE: 6/06/2018

THIS PRINT IS THE PROPERTY OF
 HVRT CORP. ALL INFORMATION
 HERE ON IS CONFIDENTIAL. IT IS LOANED SUBJECT
 TO RETURN UPON DEMAND AND IN CONDITION THAT
 IT NOT BE REPLICATED OR USED IN ANY WAY
 DETRIMENTAL TO HVRT CORP.

REVISION HISTORY					
REV	DESCRIPTION	DWG. BY	DATE	ECO	APPROVED
A	SET TO CURRENT REVISION LEVEL	SLH	11/1/2017	H1	CR
B	UPDATE/ADD DIMENSIONS	SLH	6/7/2018	H10	CR
C	ADD "TREMOR4"	SLH	4/16/2020	H13	CR
D	ADD LINE THICKNESSES	SLH	4/27/2020	H14	CR

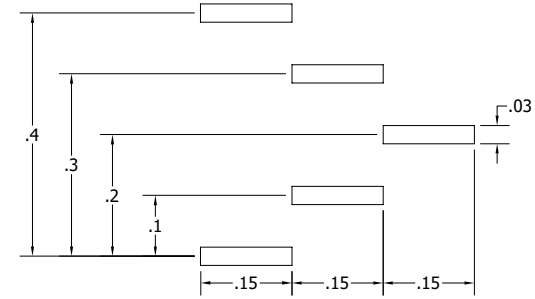
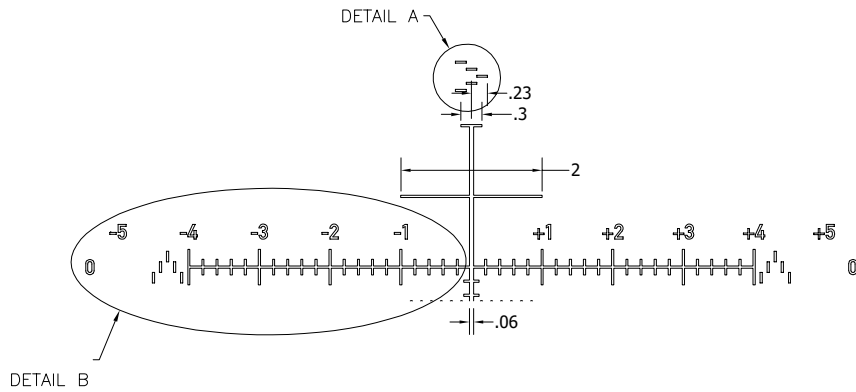

DETAIL A
 TYP 3 PLACES

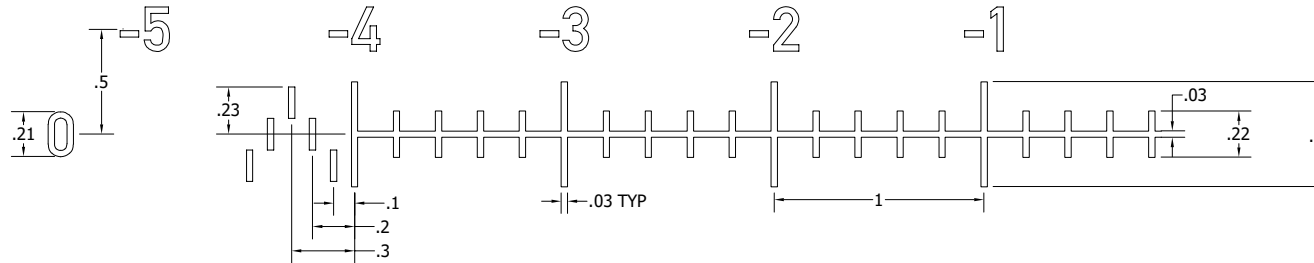

DETAIL B

FONT IS DIM 1451 Mittleschrift
 ALL DIMENSIONS ARE IN MRAD (MIL)

APPD BY:
 N. GALLERY

DATE:
 6/07/2018

APPD BY:
 C. RUNIA

DATE:
 6/07/2018

HVRT CORP.
 336 HAZEN LANE
 OROFINO, ID 83544

PART DESCRIPTION
Tremor4 - GENERIC

PART #
Tremor4 - GENERIC

DWG. BY: SLH

DATE: 6/06/2018

SHEET 3 OF 5



PLOT
 C

REV
 D

THIS PRINT IS THE PROPERTY OF HVRT CORP. ALL INFORMATION HERE ON IS CONFIDENTIAL. IT IS LOANED SUBJECT TO RETURN UPON DEMAND AND IN CONDITION THAT IT NOT BE REPLICATED OR USED IN ANY WAY DETRIMENTAL TO HVRT CORP.

REVISION HISTORY					
REV	DESCRIPTION	DWG. BY	DATE	ECO	APPROVED
A	SET TO CURRENT REVISION LEVEL	SLH	11/1/2017	H1	CR
B	UPDATE/ADD DIMENSIONS	SLH	6/7/2018	H10	CR
C	ADD "TREMOR4"	SLH	4/16/2020	H13	CR
D	ADD LINE THICKNESSES	SLH	4/27/2020	H14	CR

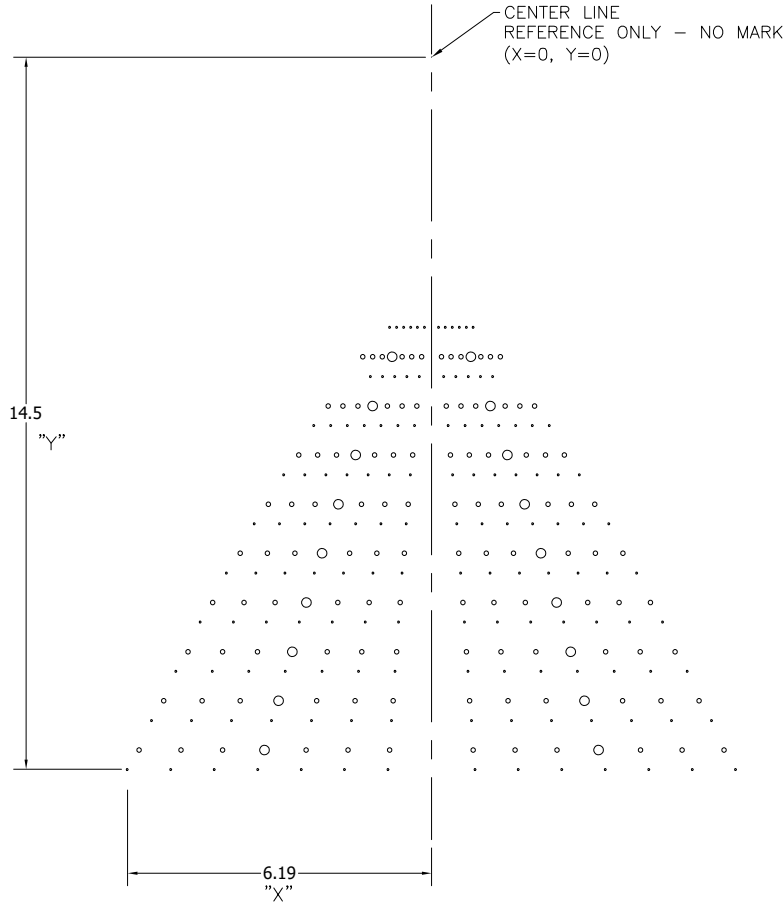

Y	X1	X2	X3	X4	X5	X6	X7	DOT DIA X4	OTHER DOT DIA
5.5	0.1417	0.2833	0.425	0.5667	0.7083	0.85	0.9917	0.05	0.05
6.1	0.2	0.4	0.6	0.8	1	1.2	1.4	0.2	0.1
6.5	0.249	0.498	0.747	0.996	1.245	1.494	1.743	0.05	0.05
7.1	0.3	0.6	0.9	1.2	1.5	1.8	2.1	0.2	0.1
7.5	0.342	0.684	1.026	1.368	1.71	2.052	2.394	0.05	0.05
8.1	0.386	0.772	1.158	1.544	1.93	2.316	2.702	0.2	0.1
8.5	0.43	0.86	1.29	1.72	2.15	2.58	3.01	0.05	0.05
9.1	0.474	0.948	1.422	1.896	2.37	2.844	3.318	0.2	0.1
9.5	0.515	1.03	1.545	2.06	2.575	3.09	3.605	0.05	0.05
10.1	0.556	1.112	1.668	2.224	2.78	3.336	3.892	0.2	0.1
10.5	0.596	1.192	1.788	2.384	2.98	3.576	4.172	0.05	0.05
11.1	0.636	1.272	1.908	2.544	3.18	3.816	4.452	0.2	0.1
11.5	0.672	1.344	2.016	2.688	3.36	4.032	4.704	0.05	0.05
12.1	0.708	1.416	2.124	2.832	3.54	4.248	4.956	0.2	0.1
12.5	0.743	1.486	2.229	2.972	3.715	4.458	5.201	0.05	0.05
13.1	0.778	1.556	2.334	3.112	3.89	4.668	5.446	0.2	0.1
13.5	0.814	1.628	2.442	3.256	4.07	4.884	5.698	0.05	0.05
14.1	0.85	1.7	2.55	3.4	4.25	5.1	5.95	0.2	0.1
14.5	0.884	1.768	2.652	3.536	4.42	5.304	6.188	0.05	0.05

ALL DIMENSIONS ARE IN MRAD (MIL)

APPD BY: N. GALLERY
DATE: 6/07/2018

APPD BY: C. RUNIA
DATE: 6/07/2018

HVRT CORP.
336 HAZEN LANE
OROFINO, ID 83544



PART DESCRIPTION		PART #	
Tremor4 - GENERIC		Tremor4 - GENERIC	
PLOT	REV	D	
C	D		
DWG. BY: SLH		DATE: 6/06/2018	SHEET 4 OF 5

THIS PRINT IS THE PROPERTY OF
 HVRT CORP. ALL INFORMATION
 HERE ON IS CONFIDENTIAL. IT IS LOANED SUBJECT
 TO RETURN UPON DEMAND AND IN CONDITION THAT
 IT NOT BE REPLICATED OR USED IN ANY WAY
 DETRIMENTAL TO HVRT CORP.

REVISION HISTORY					
REV	DESCRIPTION	DWG. BY	DATE	ECO	APPROVED
A	SET TO CURRENT REVISION LEVEL	SLH	11/1/2017	H1	CR
B	UPDATE/ADD DIMENSIONS	SLH	6/7/2018	H10	CR
C	ADD "TREMOR4"	SLH	4/16/2020	H13	CR
D	ADD LINE THICKNESSES	SLH	4/27/2020	H14	CR

HIGH MAGNIFICATION VIEW

LOW MAGNIFICATION VIEW

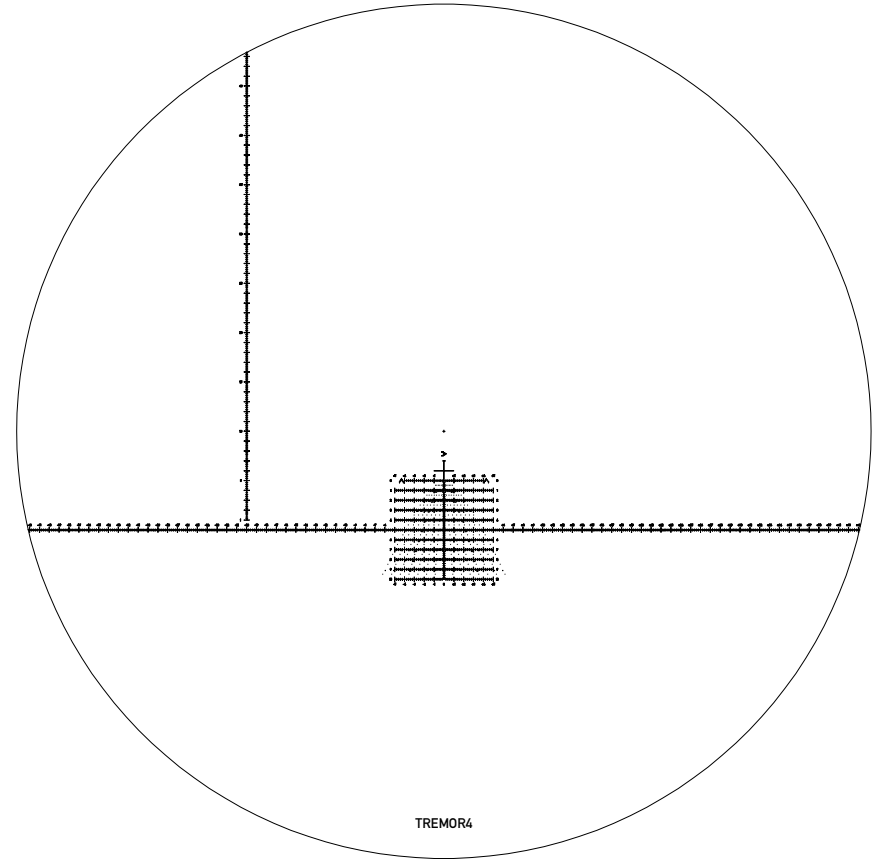
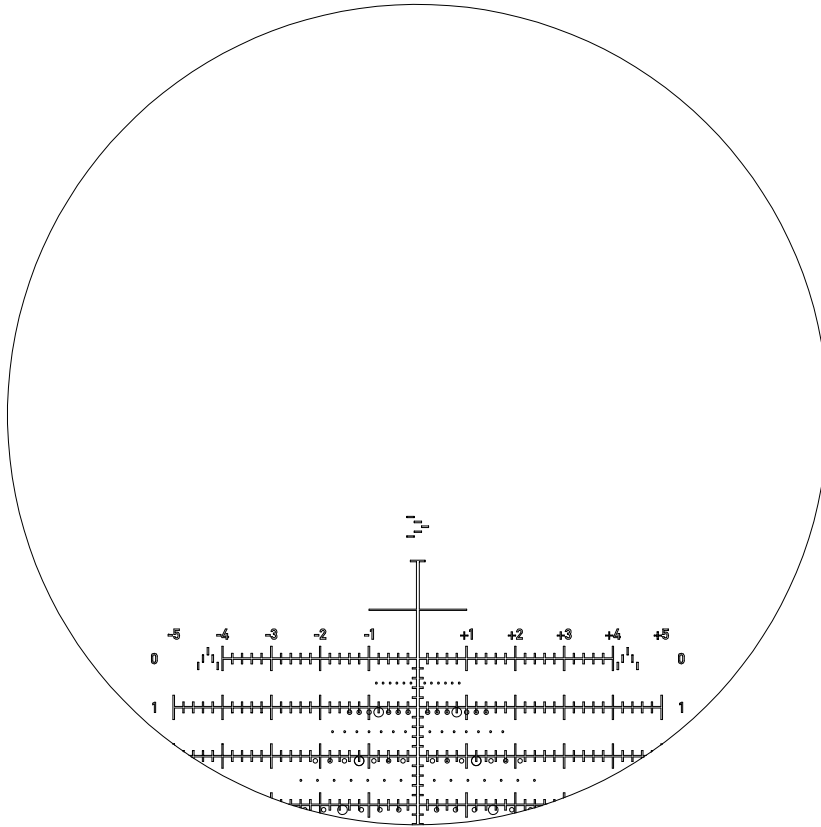

TREMOR4

ALL DIMENSIONS ARE IN MRAD (MIL)

APPD BY: N. GALLERY	DATE: 6/07/2018
APPD BY: C. RUNIA	DATE: 6/07/2018
HVRT CORP. 336 HAZEN LANE OROFINO, ID 83544	

	
PART DESCRIPTION Tremor4 - GENERIC	
PART # Tremor4 - GENERIC	
PLOT C	REV D
DWG. BY: SLH	DATE: 6/06/2018
SHEET 5 OF 5	